

KIWATEK
ONDO-F370-04

Dimensions:

178.00mm(W) x 261.60mm (D) x 147.80mm (H)(7.0" x 10.3" x 5.8")

Motherboard Spec.

For Mini-itx Motherboard.

Front Panel:

Power SW . Power LED . HDD LED .
USB 2.0 Port x 2 .

Back Panel:

Expansion PCI Raw slot x 2 .
USB 3.0 Port x 4 .
VGA x 1 .
COM Port x 6 .
HDMI x 1 .
Gigabit LAN x 2 .
Display Port x 2 .
Audio IN/OUT .
12V DC in

Drive bays:

2.5" HDD x 1

Power Input:

C7(80W)

Construction:

Metal chassis
Aluminum chassis
Low Operation temperature

RoHS Compliant

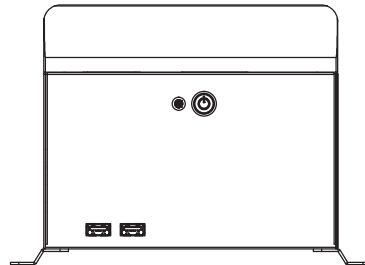
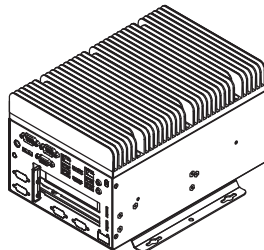
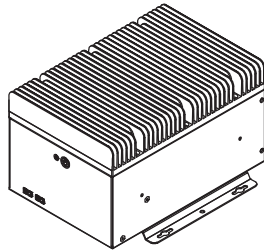
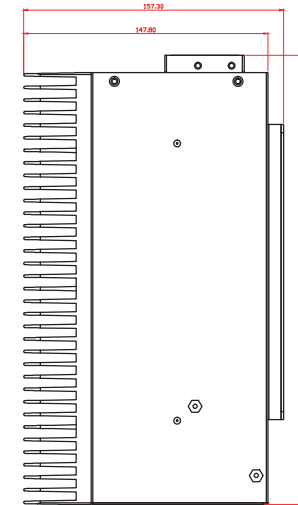
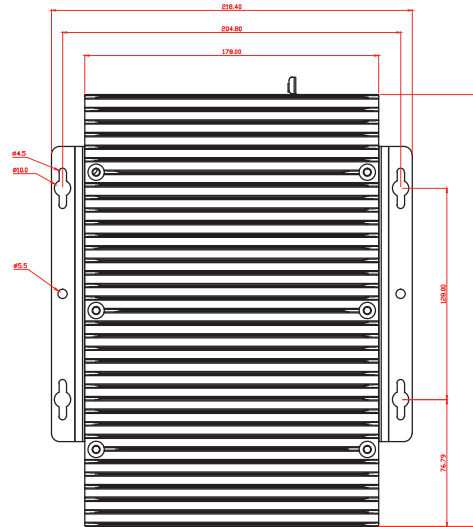
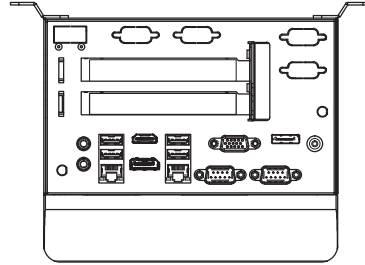

UNIT : mm
Rev : A
Date : 2016.05.17
PAGE : 1 / 1